

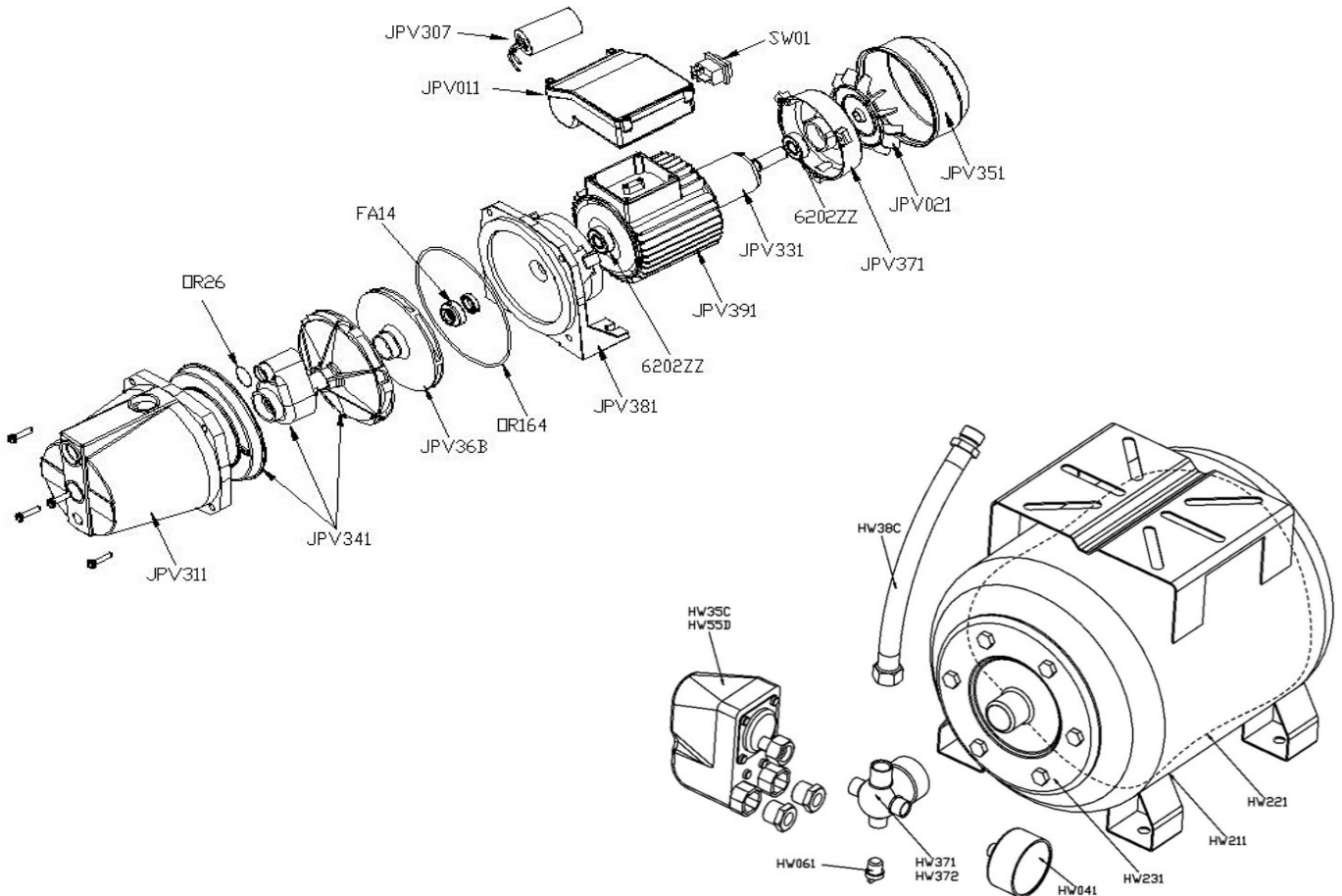











VB25/1300B

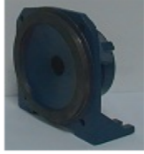

No	Code	Name	Qty	No	Code	Name	Qty
1	026016	Pump case	1	25		Corrugated washer	1
2		Screw	1	26	029972	Rear badge plate	1
3		„O” ring 12*2	1	27		Screw	3
4		Plastic cap	2	28		Washer	3
5	026017	Anti-spinning piece	0	29	026023	Fan	1
6		„O” ring 26*2	1	30	026024	Fan enclosure	1
7	026018	Diffuser	1	31	026025	Condenser housing	1
8	026019	Impeller	1	32		Screw	6
9		Screw nut	1	33		„O” ring 140*1,5	1
10		Washer	1	34	029868	Switch	1
11		Washer	1	35		Condenser	1
12		Key	1	36		„O” ring 32*2,5	1
13	026020	Axial gasket	1	37		Condenser fixing	1
14	026021	„O” ring 164*3,5	1	38		Cable shoe	8
15		Diffuser	1	39		Shrinkable tube	8
16	026022	Motor front badge plate	1	40		Connection terminal	1
17		Screw	2	41		Screw nut	6
18		Washer	2	42		Washer	6
19		Screw	2	43		Screw	7
20	010771	Bearing	2	44		Washer	4
21		Handgrip	1	45		Washer	1
22	029973	Rotor	1	46		Washer	1
23	029974	Combined stator	1	47		Cable shoe	4
24		Base	1	48		Shrinkable tube	4

VB 25/1300B - parts that can be ordered

Serial no.	Description	Note	Picture
1	Pump case	Cast iron case, with 1" connections	
5	Anti-spinning piece	Anti-spinning piece missing from older models	
6	„O” ring 26*2	Sealing ring on the suction part of the injector	
7	Diffuser	Plastic component in the pump case, with anti-spinning piece	
8	Impeller	Ø 130 mm, 6-blade closed, bronze impeller. Blade height: 6.2 mm	
13	Axial gasket	Ceramic-insert gasket for the 14mm shaft	
14	„O” ring 164*3,5	Gasket between the pump case and the motor front badge plate	
16	Motor front badge plate	Motor badge plate on the drive side	
20	Bearing	Ball bearing	
21	Handgrip	Bent steel lug	
22	Rotor	239 mm shaft length, with Ø54.4 mm, 86mm long iron core	
23	Combined stator	1300 W coil, with Ø 110 mm, 85mm long iron core, in finned aluminium housing 1300 W coil, with Ø 110 mm, 85mm long iron core, in finned aluminium housing	
26	Rear badge plate	Aluminium badge plate on the side opposite to the drive	
29	Fan	Plastic fan blade, on spliced shaft	

VB 25/1300B - parts that can be ordered

Serial no.	Description	Note	Picture
30	Fan enclosure	Cooling fan enclosure	
31	Condenser housing	Plastic cabinet containing electric fittings	
34	Switch	16A/250V red switching key	
35	Condenser	16uF/400V condenser	
54	Tank	24-litre painted steel tank. Complete with fittings.	
55	Rubber sack	EPDM rubber sack in the 24-litre tank.	
56	Joining flange	Steel front plate for the 24-litre tank, with 1" thread	
65	Manometer	6-bar manometer	
66	Baroswitch	Baroswitch with 3/8" thread, rubber-ring gasket	
67	Baroswitch	Baroswitch with 1/4" thread, plate gasket	
68	Close nipple	Plastic screw in bronze distribution piece for water discharging	
69	Bronze joining piece	Joining piece for the 3/8" HW35C baroswitch with rubber-ring gasket	
70	Bronze joining piece	Joining piece for the 1/4" HW55D baroswitch with plate gasket	
71	Flexible pipe	265 mm long flexible pipe with 3/8" thread, 1/2" pipe union	